

Rekta 30x110 Direct/Indirect - satin - HO 150mA - RAL
04.13700554-9999

Fixture details

Mounting	Pendant
Light emission	Direct-Indirect
Fitting cover	satin diffusor
Protection rate	IP 20
Housing	Aluminium
Finish	RAL colour at your choice
Certificates	CE, ISO 9001

Electric details

Protection class	I
Supply	230V
Control gear box	Current driver

Lamp details

Lamptype	LED 4000K
Wattage	3,2W
Gross luminous flux	6075
Luminaire power	31,6W
Number	9
Lifetime LED module	L80/B10 > 102000h
Color tolerance	MacAdam 3
CRI	>80

Photometric details

UGR	>19
CIE Fluxcode	50 80 96 100 67
CIE Fluxcode Indirect	00 00 00 00 67

Dimensions

A	1410 mm
---	---------

Remarks

Suspended luminaire - Direct/Indirect - HO 150mA - satin (flush) - RAL

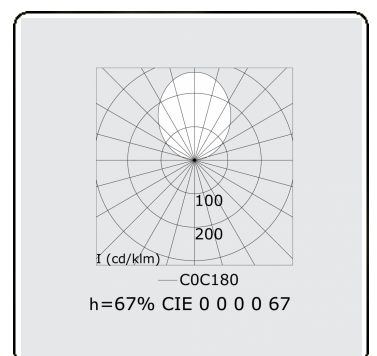
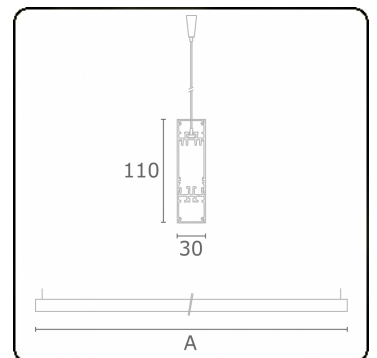

ENERGY

Verrijgbaar op aanvraag.

Disponible sur demande.

Available on request.

Auf Anfrage.

WXYZ
kWh/1000h

MULTILINE®

2019/2015